

From Eye to Insight

Leica
MICROSYSTEMS

Premium Surgical Microscope

STAY FOCUSED

M530 OHX with FusionOptics



European Brochure Version



STAY FOCUSED

Focus on your patient, focus on your surgery and let the M530 OHX surgical microscope support you to achieve the best possible outcome.

Designed to be your trusted partner in the OR, the M530 OHX microscope unites the exclusive innovation FusionOptics with a flexible, ergonomic design and customizable imaging options. Experience outstanding visualization and feel the ongoing benefits of a comfortable working position - for you and your team.

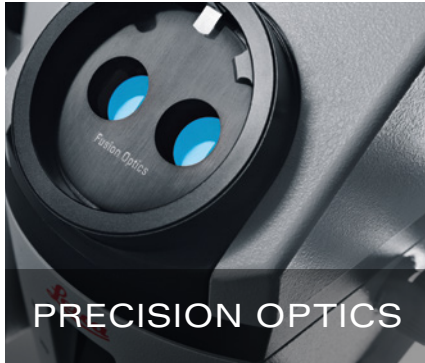

See more with optical innovations

- > FusionOptics for high resolution with enhanced depth of field
- > Better visibility in deep cavities

See pages 4 to 5.



Comfort and efficiency built in

- > More space to work
- > Full integration
- > Flexible positioning for everyone
- > Superior maneuverability

See pages 6 to 7.



Customizable to your needs

- Individually configurable and upgradeable
- > Select from 2D or 3D HD visualization and recording and image injection of data from IGS systems
 - > Augment your intra-surgical visualization with your choice of fluorescence imaging

See pages 8 to 11.



Patient safety first

- > Automatic illumination controls help protect skin
- > Consistent light intensity
- > Hygiene protection built in

See pages 12 to 13.

A person is shown from the back, looking through a microscope. The image is overlaid with a diagram illustrating the FusionOptics technology. Two light paths are shown: a red path on the left and a white path on the right. These paths converge at the top of the person's head, where two overlapping circles (one red, one white) represent the eyes. The diagram shows how the brain merges the two different visual inputs into a single, clear image. The background is a dark, gradient blue.

SEE MORE
WITH OPTICAL
INNOVATION

FusionOptics technology combined with intelligent illumination and apochromatic optics delivers astounding image quality.

See more, refocus less with FusionOptics

Achieving depth of field and high resolution in one image has always been a challenge. Leica Microsystems has developed an innovative new approach to overcome this challenge: FusionOptics. Making use of the power of the human brain, FusionOptics technology captures different information from each of the two beam paths, delivering the highest possible resolution to the left eye and maximum depth of field to the right. The brain then easily merges the visual information into a single, optimal spatial image with amazing clarity and a significantly expanded area in full focus. A larger area in full focus also means you need to refocus less frequently, potentially enhancing your workflow efficiency. FusionOptics helps you to stay focused, in every sense of the word.

FusionOptics Technology

1. Two separate beam paths
2. One beam path provides depth of field
3. The other provides high resolution
4. The brain merges the two images into a single, optimal spatial image

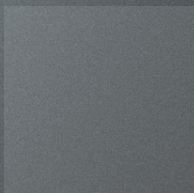

Deep insights

Small Angle Illumination (SAI) combined with bright 400-Watt xenon light provides a concentrated light beam that penetrates to the bottom of deep, narrow cavities. The result is better illumination with less shadow. SAI provides you with more details and an improved depth perception.

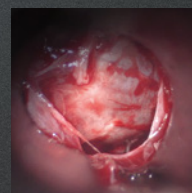

Without SAI
(400 mm working distance)

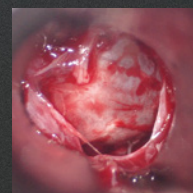

With SAI
(400 mm working distance)

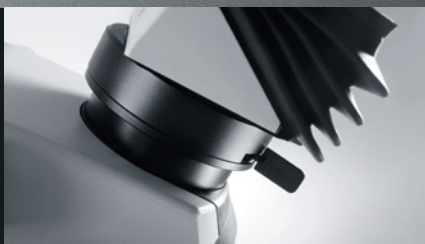

Magnification Multiplier for 40% boost



SpeedSpot for fast focusing



Fine focus for rear assistant

See even more, fast

Adapt the M530 OHX optics to meet the requirements of your surgery and your team

- > Additional 40% magnification boost with the optional Magnification Multiplier
- > Fast focusing with two laser beams acting as a focusing reference to quickly provide a defined focus point for all three viewing positions (surgeon, assistant, camera)
- > Independent fine focus for the rear assistant with a range of +/- 5 diopters
- > A selection of binoculars all with full 360°-rotation to allow adjustment to different heights and positioning needs - no need to swap binoculars

COMFORT AND EFFICIENCY BUILT IN

Ergonomic working positions, smooth maneuverability and ease of use for comfort and streamlined workflow.

The M530 OHX surgical microscope is designed to fully adapt to you and the needs of your surgical specialty. Its intelligent ergonomic features and smooth maneuverability limit physical distraction and workflow interruptions so you can stay even more focused on the critical task at hand.



Compact and fully integrated

Ease of use

Setting up the M530 OHX microscope is fast and simple with the intuitive touch-screen control panel. For your comfort and efficiency key functions can be controlled via handgrip, foot or mouth switches. To confirm settings just glance to the surgeon information panel above the optics carrier.



Full range of movement and tilt of the optics carrier

Smooth handling

With cables routed internally and electromagnetic brakes, maneuvering is smooth and effortless, reducing the potential strain of harsh movements. For unmatched positioning flexibility, the optics carrier has an extensive range of movement. Fast stabilization keeps workflow interruptions to a minimum.

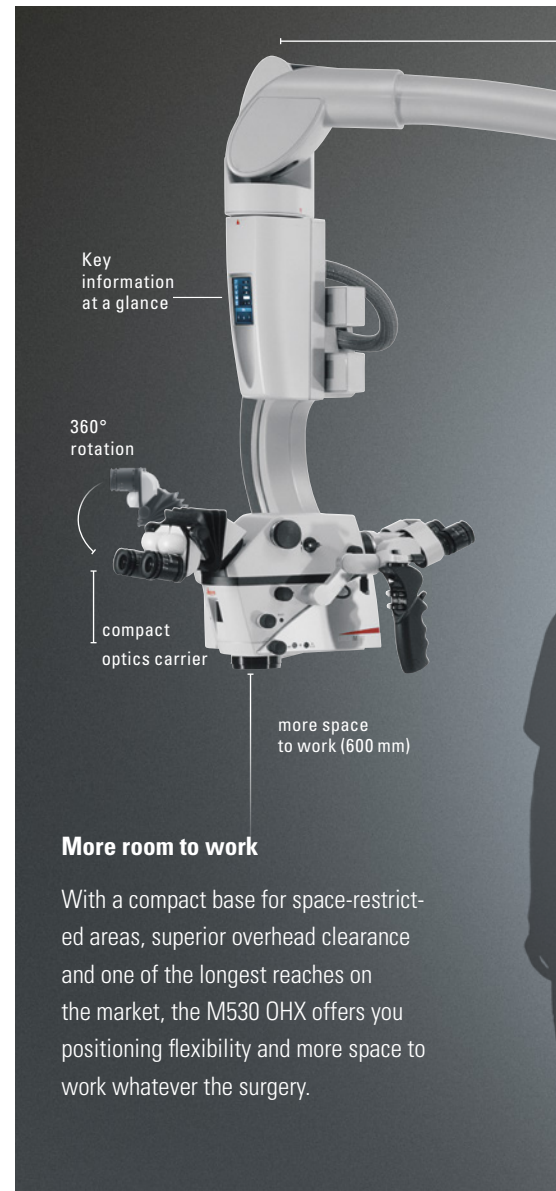

More room to work

With a compact base for space-restricted areas, superior overhead clearance and one of the longest reaches on the market, the M530 OHX offers you positioning flexibility and more space to work whatever the surgery.



Auto balance conveniently located next to the left handgrip

Perfect balance

The time-saving auto-balance system requires only two pushes of one button to fully balance all six axes. To quickly and accurately re-balance the microscope intraoperatively, even through a sterile drape, simply push the AC/BC button, conveniently located by the left handgrip.



Superior reach

superior overhead clearance

A range of multiple 2D and 3D screens

LEICA OHX

Positioned for your comfort

- > Compact optics carrier design means less distance from eye-piece to objective lens so arms can remain in a natural position and are not over extended
- > Accommodates different operating positions and body frames with a range of binoculars for main surgeon and assistant all with full 360°-rotation
- > The design of the optics carrier means that the opposite assistant can also achieve a comfortable upright working posture
- > Large 600 mm working distance allows for easy maneuvering and passing of instruments enabling the microscope to be used in spine procedures where previously only loupes could be used



Comfortable working posture and large free working space during a spine surgery

CUSTOMIZABLE TO YOUR NEEDS

A modular yet integrated design for configuration flexibility today and in the future.

The streamlined, cable-free M530 optics carriers were developed with a modular Open Architecture design to allow for maximum configuration flexibility. Choose the optics carrier to best suit your surgery needs and then configure with imaging and recording options. And if your requirements change or you want to add a new imaging technology in the future, the upgrade-ready design makes it simple.



Basic configuration: Integrated video adapter

The compact design of the IVA530 optics carrier is ideal for otolaryngology and neurotology. With no opposite assistant, more light is directed to the main surgeon and side assistant. The integrated video adapter has a built-in depth enhancer, for outstanding screen display and recording.



Standard configuration: Flexibility for your surgery type

The ULT530 optics carrier is the optimal configuration for neurosurgery, spine and plastic reconstructive surgery. There are interfaces for left, right and rear assistant binoculars as well as optional integrated HD C100 camera, FL400 and FL560 fluorescence.



Advanced: Integrated CaptiView image injection into the eyepieces

The M530 OHX can be supplied with fully integrated FL800 vascular fluorescence and GLOW800 Augmented Reality fluorescence CaptiView image injection. Surgeons can inject data from external and internal sources, such as FL800, GLOW800, MRI, CT, and Image Guided Surgery (IGS) systems directly into the eyepieces.



Three-dimensional view for all

Integrated 3D* visualization and recording for exoscopic surgery is also available. 3D imagery can greatly enhance microsurgery education, providing staff and students with the same 3D view as the surgeon during live surgery or a seminar.



Ready for today and tomorrow

The OpenArchitecture design of the microscope allows easy integration of systems such as the user-friendly Med X Change HDMD full HD digital recording system or IGS in combination with the CaptiView module. Upgrade easily when your requirements change or when new imaging technologies become available.



Fully integrated and under control

HD 2D and 3D cameras, fluorescence modules, documentation systems and all cables are fully integrated inside the microscope. Not only does this give a sleek, clean appearance, it ensures seamless integration and flexible control via the handgrip or optional mouth and foot switches.

*3D visualization requires the hardware of the GLOW platform.

FULL HD IMAGE INJECTION, FULL CONFIDENCE



With CaptiView image injection you see full-HD visual data with 500:1 contrast directly in the field of view, for confident surgical decisions without interruption.

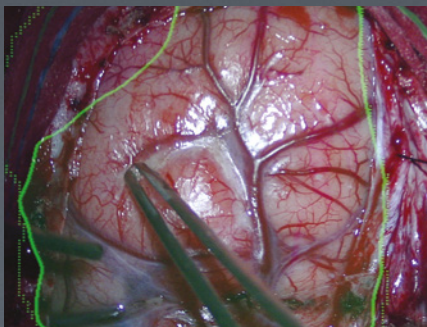

Every detail you need before your eyes

- > Full-HD 1080p resolution and 500:1 contrast
- > Overlay data onto the live surgical view or see a full image
- > Data can be injected from an IGS system, FL800 fluorescence or GLOW800 AR fluorescence and also seen on the microscope's monitor
- > View in left, right or both* eyepieces

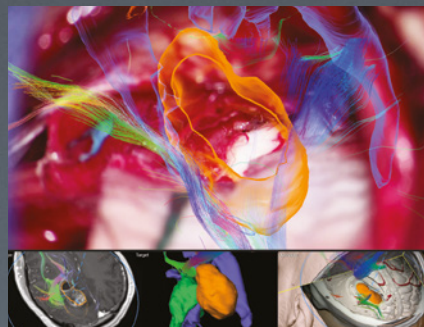

Integration avoids interruption

CaptiView image injection is compatible with leading IGS systems and fully integrated with your M530 OHX microscope for an interruption-free workflow. You no longer need to switch between eyepieces and screen, and a single touch of the microscope handgrip or footswitch activates CaptiView.



Share your view, share your skill

A shared view for main surgeon and assistant enhances the assistant's ability to follow each delicate surgical action. Full HD display and recording, complete with injected images, enable later review and teaching outside of the OR.

ENHANCED VIEW WITH FLUORESCENCE AND GLOW AUGMENTED REALITY

Augment your intra-surgical visualization with your choice of fluorescence imaging.

To enhance your visualization and support intra-surgical assessment, the M530 OHX microscope can be supplied with groundbreaking GLOW800 Augmented Reality vascular fluorescence, FL800 fluorescence, FL560 fluorescence, and FL400 oncological fluorescence. With only a few button clicks, you can easily switch from white light to fluorescence mode or between fluorescence modes. Brilliant HD fluorescence video can be easily viewed, in the oculars with CaptiView, on screen and also recorded. For best viewing results, the built-in Mode Control video technology automatically optimizes the settings of cameras according to the selected mode.



Aneurysm Clipping viewed with GLOW800

GLOW800 Augmented Reality fluorescence

Next generation GLOW800 augmented reality fluorescence takes the high contrast of NIR imaging with ICG and combines it with white light. The result is a single view of natural-colored cerebral anatomy augmented by real-time vascular flow.

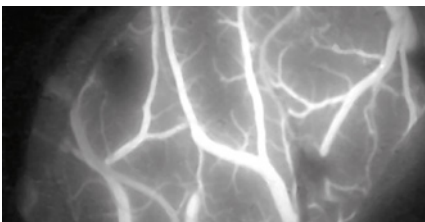

Neurovascular structure viewed with FL800 and ICG

FL800 fluorescence

The FL800 ULT intraoperative video-angiography module is used in conjunction with ICG fluorescent agent and allows surgeons to see blood flow through vessels in real-time during surgery.

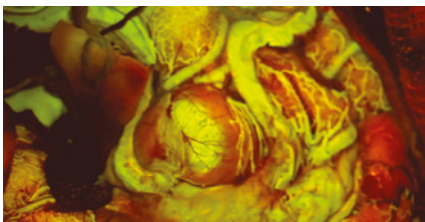

AVM viewed with FL560

FL560 fluorescence

The FL560 for M530 module is designed to enable fluorescence observation of fluorophores with an excitation peak between ~460 nm and ~500 nm (blue) and fluorescence emission observation comprising the green, yellow, and red spectrum in a spectral band above ~510 nm.

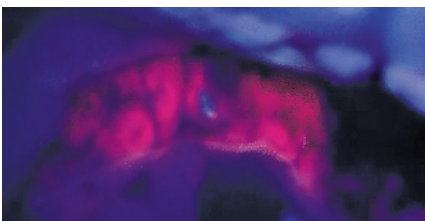

Glioblastoma tumor viewed with FL400 and 5-ALA

FL400 oncological fluorescence

The fluorescence module FL400 is used during open neurosurgery in conjunction with the active substance 5 aminolevulinic acid (5-ALA). It supports resection by allowing differentiation of tumor tissue from healthy brain tissue.

*Product availability may vary depending on regulatory clearance. For more information, please check with your local Leica Microsystems representative.



REINFORCE PATIENT SAFETY

Innovative illumination controls, fail safes and design features help you optimize patient safety and minimize interruptions.

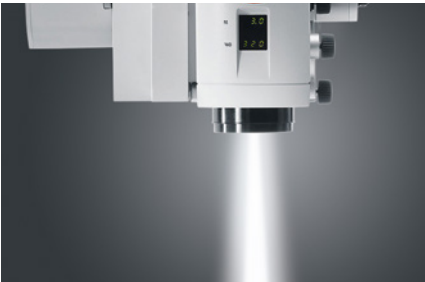

Bright 400-Watt xenon illumination

Reliable illumination system

The M530 OHX microscope features two redundant 400-Watt xenon arc-lamp illumination systems, with independent lamps and boards. The microscope automatically switches to the second illumination system when needed.



Safe, maximum brightness

Maximum brightness at all times

The efficient light transmission of the M530 OHX ensures that the maximum possible amount of light is always being provided. Therefore, you can operate at safer light levels and still see more than ever before.



Antimicrobial coating to minimize pathogens

Protection for team and patients

Leica surgical microscopes are designed to support your multiple clinical needs including your hygiene protocols. Our microscopes are therefore coated with a paint which is designed to provide an antimicrobial effect on surfaces.



Luxmeter for consistent lighting

BrightCare Plus compensates for decreased light intensity as bulbs age to ensure consistent lighting. With the internal luxmeter providing real-time light intensity data to the BrightCare Plus system, light intensity is calculated on actual bulb output, not by using an algorithm or formula.



Separate operating systems for video and microscope

Stay operational

To ensure full operability the microscope and the video have completely independent operating systems. In the rare case of a video system error, the microscope retains full functionality and surgery can continue uninterrupted.

OPTIMAL LIGHT INTENSITY

BrightCare Plus optimizes the light intensity relative to the working distance.

Max. illumination



Long working distance.

Max. illumination (BrightCare Plus inactive)

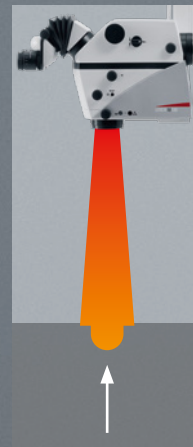

Decreased working distance at same illumination setting (left) creates burn potential in conventional microscopes.

Microscope with BrightCare Plus activated

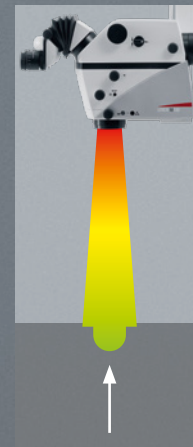

BrightCare Plus automatically adapts light intensity to the working distance, providing safer illumination (up to 60% reduction of light intensity).

OPTIMAL FIELD OF ILLUMINATION

Autolris automatically adjusts the diaphragm so that only the visible area is illuminated.

Conventional microscope at low magnification

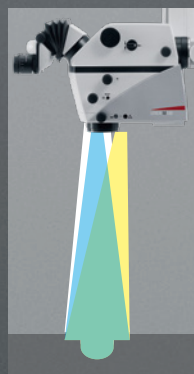

At low magnification, the field of illumination (yellow) fills the field of view (green) completely.

Conventional microscope at high magnification

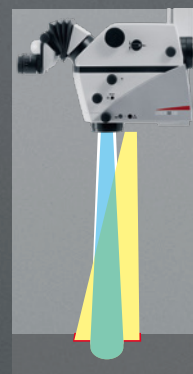

Previously, as magnification increased, the field of view became smaller, but the illumination outside the field of view could potentially cause tissue burns (red).

Leica microscope with Autolris

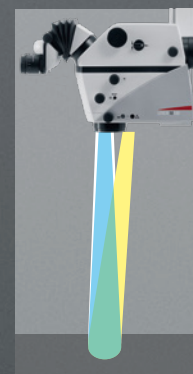

Autolris automatically works with the zoom, decreasing the field of illumination as the field of view decreases. There is no peripheral illumination to cause tissue burns outside the field of view.

TECHNICAL SPECIFICATIONS

OPTICS AND ILLUMINATION

FusionOptics	For increased depth of field and high resolution for main surgeon and opposite assistant
Fully apochromatic optics	For high contrast, natural colors without chromatic aberrations
Magnification	6:1 zoom, motorized
Total magnification	1.0× to 12.1× with 10× eyepiece
Magnification multiplier	1.4× (optional)
Focus	Motorized via multifocal lens, with manual adjustment
Fine focus	±5 diopter available for opposite assistant (ULT)
Objective / working distance	225–600 mm, motorized multifocal lens, continuously adjustable and manual adjustment option
Field of view	17.4 to 210 mm ø with 10× eyepiece
Eyepieces	Wide-field eyepieces for persons wearing glasses 8.3×, 10× and 12.5× dioptic adjustment, ±5 diopter settings and adjustable eyecup
Integrated 360° rotatable adapter	For main surgeon binocular (IVA, ULT) and opposite assistant (ULT)
Illumination	<ul style="list-style-type: none"> - High-output 2x 400-W redundant xenon arc-lamp systems via fiber optics cable - Continuously variable illumination field diameter with Gaussian distribution - Continuously adjustable brightness at constant color temperature
SpeedSpot	Laser focusing aid for fast and exact positioning of the microscope

MANEUVERABILITY

Optics	<ul style="list-style-type: none"> - 540° rotation - 50° lateral tilt to left and right - -30° /+120° inclination tilt
XY speed	Zoom linked XY speed
Balancing	One button/two push complete automatic balancing of stand and optics
Intraoperative balancing	Automatic intraoperative AC/BC balancing of AC and BC axes (not available for Japan).
Brakes	Floor stand with 6 electromagnetic brakes

Carrier for monitor	700 mm flexible arm with 4 axis for rotation and inclination
---------------------	--

MODULARITY

Basic: IVA530	<ul style="list-style-type: none"> - Full stereo view for main surgeon, semi stereo view for 2 side assistants and C-mount interface for camera (HD or SD) - Light distribution: 67% for surgeon, 23% for side assistant, 20% for C-mount port
Standard: ULT530	<ul style="list-style-type: none"> - Full stereo view for main surgeon and opposite assistant, semi stereo view for up to 2 side assistants - High sensitivity, built-in IR video camera with 1/2" CCD - Optional integrated HD Camera (HD C100), FL400, and FL560 - Light distribution: 50% for main surgeon, either 20% for each side assistant or 40% for opposite assistant
FL400	FL400 oncological fluorescence observation filter module
FL560	FL560 investigational fluorescence observation filter module
Advanced: FL800 ULT &/or CaptiView image injection	<ul style="list-style-type: none"> - Full stereo view for main surgeon and opposite assistant, semi stereo view for up to 2 side assistants - CaptiView HD image injection (optional) - FL800 vascular fluorescence with built-in NIR camera (optional) - Optional: C-mount interface for camera (HD or SD)
OpenArchitecture	<ul style="list-style-type: none"> - Easy integration of neuronavigation systems and laser systems (please ask your Leica Microsystems representative) - Prepared for integration of video camera system and digital recording system
Connectors	<ul style="list-style-type: none"> - Numerous built-in connectors for video, IGS and control data transfer - Internal power supply 12 VDC, 19 VDC and AC terminals
2D/3D HD Video	Fully integrated 2D HD and/or 3D HD video and recording

CONTROL

Control unit	<ul style="list-style-type: none"> - Programmable touch-screen with user-friendly Graphical User Interface for control of microscope and stand - Built-in electronic auto-diagnosis and user support - Software independent hard keys for illumination and auto-balancing - Indicator for main/backup illumination and fluorescence modes
Control elements	<ul style="list-style-type: none"> - Pistol handle with 10 programmable functions - Optional mouthswitch - Optional 12-function wireless footswitch
IR sensor	For remote control of the external HD C100 camera

SAFETY

Autolris	Built-in automatic zoom-synchronized illumination field diameter, with manual override and reset feature
BrightCare Plus	Safety function through working distance-dependent limitation of the brightness, controlled by a built-in luxmeter

CONSTRUCTION

Base	690 × 690 mm with four 360° rotating casters with a diameter of 150 mm each, one parking brake
Materials	All solid metal construction coated with antimicrobial paint
Load	Min. 6.7 kg, max. 12.2 kg from microscope dovetail ring interface
Weight	Approx. 320 kg without load
Indicator	LEDs for fluorescence mode status and video record status

TECHNICAL DATA

Ambient conditions in use	<ul style="list-style-type: none"> - +10 °C to +40 °C - +50 °F to +104 °F - 30% to 95% rel. humidity - 800 mbar to 1060 mbar atmospheric pressure
Power connection	<ul style="list-style-type: none"> - 1600 VA 50/60 Hz - 100 V, 120 V, 220 V, 240 V (+10%/-15%) - 2 × T10 AL 100/120 V - 2 × T8 AL 220/240 V
Protection class	Class 1

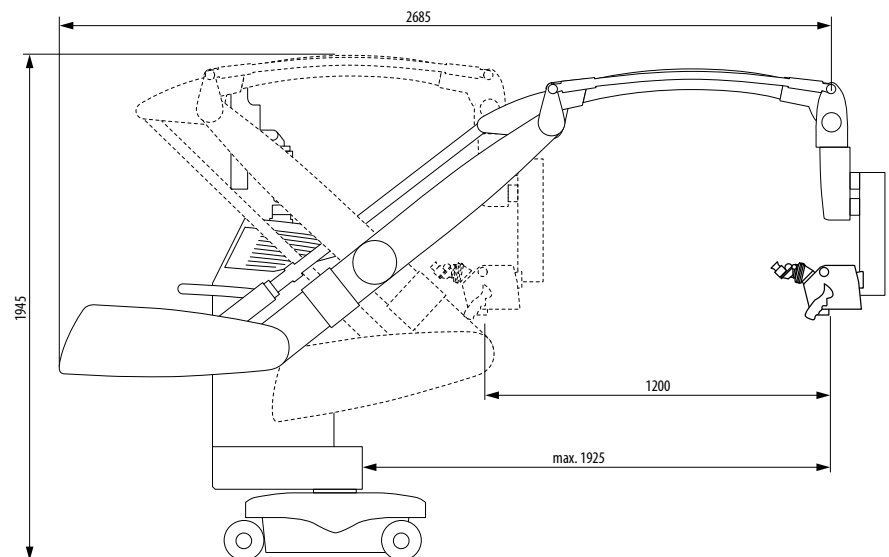
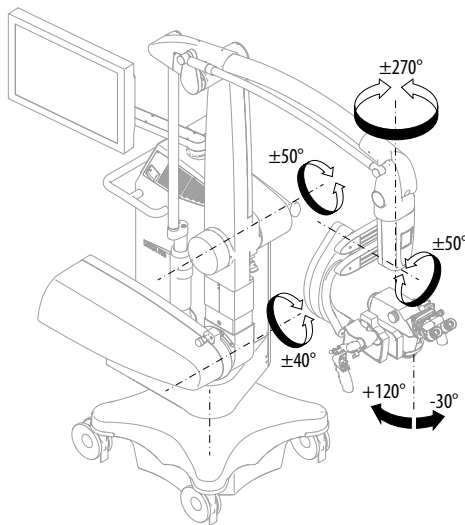



Leica Microsystems (Schweiz) AG
Max Schmidheiny-Strasse 201
9435 Heerbrugg, Switzerland

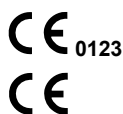

Class IIa FL800 ULT, GLOW800

Class I surgical microscope Leica M530 OHX incl. accessories

Not all products or services are approved or offered in every market and approved labeling and instructions may vary between countries.
Please contact your local Leica representative for details.

Leica Microsystems (Schweiz) AG · Max Schmidheiny Strasse 201 · CH-9435 Heerbrugg
T +41 71 726 3333 · F +41 71 726 3399

www.leica-microsystems.com

CONNECT
WITH US!

