

From Eye to Insight

Leica
MICROSYSTEMS



Microelectronics and Semiconductor Industry

FAST DETECTION –
FAST ACTION

DM3XL Inspection System

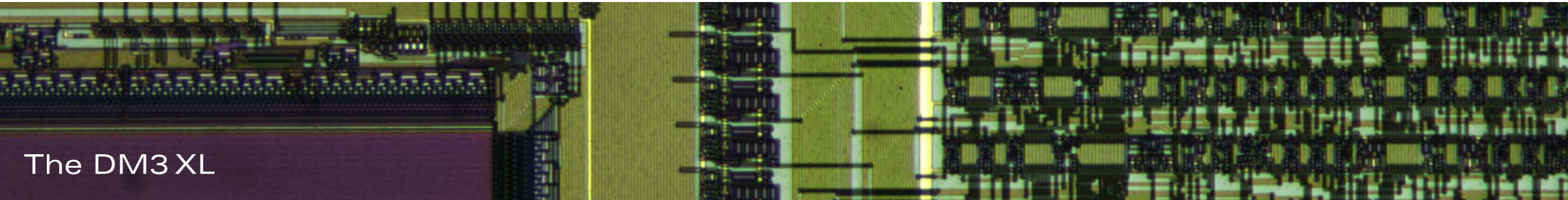

The DM3 XL



High efficiency for inspection of 6" samples

Inspection, process control, or defect and failure analysis is all about speed: Any defect can hold production up; you need a microscope that allows your team to detect defects as fast and as accurately as possible.

The DM3 XL Inspection System helps you to save inspection time. Make use of the 30% increased field of view of the unique macro objective. The DM3 XL provides high-end quality for a mid-range budget – because you have no time for compromise.



See more, work faster

Seeing more means working faster. The DM3 XL inspection system provides a unique objective to rapidly scan large components up to 6". The macro overview objective with a magnification of 0.7x captures a field of view of 35.7 mm at once – 30% more than with available scanning objectives.

That which is invisible for conventional scanning objectives can't hide from the macro overview: insufficient development at the edge or within the center of a wafer as well as uneven radial film thicknesses can be made visible and enhance your yield rate.

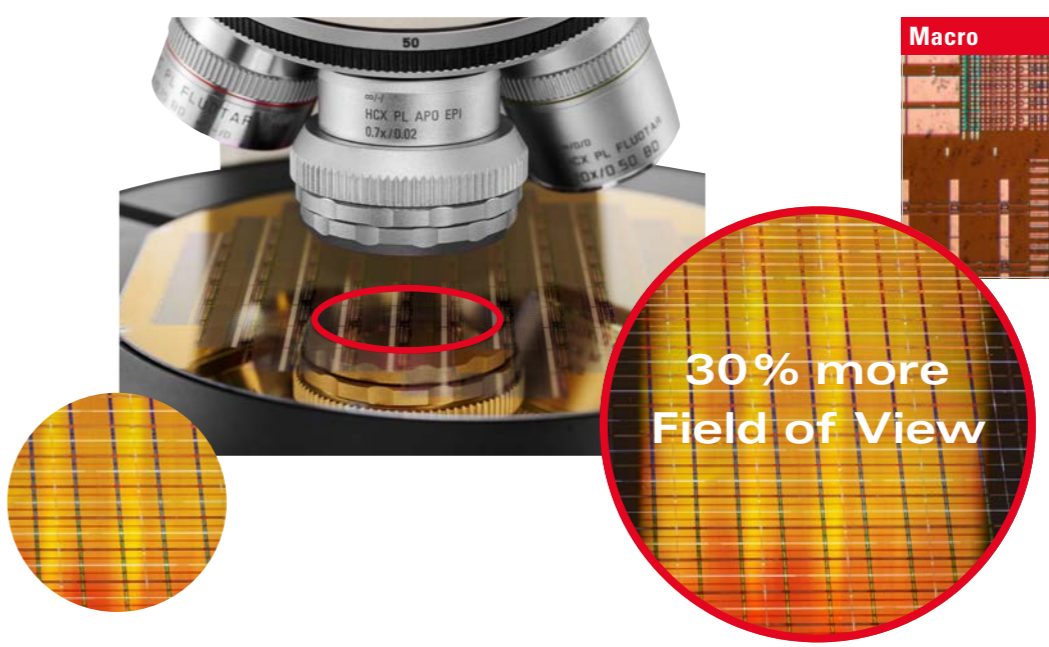
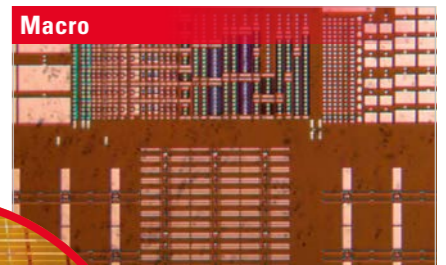
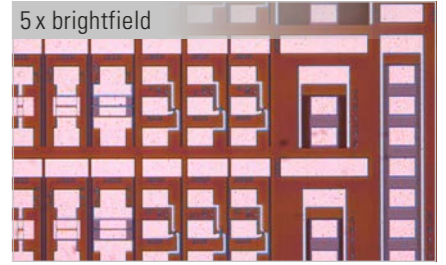
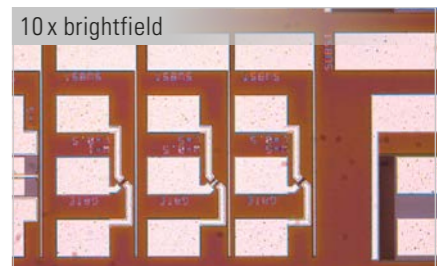

5 mm field of view with conventional objective

35.7 mm field of view with Macro objective

The Perfect Match

LED for all contrast methods

The DM3 XL uses LED illumination for all contrast methods: brightfield, darkfield, differential interference contrast (DIC), polarized light, and oblique illumination. LED illumination provides a constant color temperature and offers real-color imaging at all intensity levels. This allows you to always see the sample in the same color and get reproducible results. With a long lifetime of 35,000 hours and low power consumption, LEDs also offer an enormous cost savings potential and optimize the company's carbon footprint.

- > True-to-life color imaging at all intensity levels
- > Adjustment-free
- > No down-time due to bulb exchange



LED Illumination – “constant” light

- > Ultra bright, high-power LED illumination
- > Constant color temperature of 4500 K
- > True to life color imaging at all intensity levels
- > Long lifetime (35k h) at 8 h/day = 20 years
- > Adjustment-free
- > No down time (bulb exchange)
- > For brightfield (BF), darkfield (DF), Differential Interference Contrast (DIC), Polarization (POL), Fluorescence (FL) and Oblique Illumination
- > No heat production
- > Intensity perception higher than 100 W halogen bulb



High performance objectives from Leica

With the DM3 XL, you can benefit from dedicated optical features – like oblique illumination or in-depth darkfield contrast – at an affordable price.

- > Examine sides, edges, or chippings with oblique illumination
- > See smallest particles with in-depth darkfield objectives
- > Conform to international standard

The oblique illumination is ideally suited to examine sides, edges or chippings. It allows you to illuminate your sample from different angles and is an easy and effective way to visualize topographies – even transparent topographies due to residual resist.

In-depth darkfield contrast provides dramatically increased sensitivity – especially for the detection of micro-scratches or small particles in lower layers of your sample. Additionally, the large working distance of the darkfield objectives protects precious samples from inadvertent damage during inspection.

Of course, the DM3 XL conforms to international specifications and standards such as SEMI S2/S8 or CE.

Work Comfortably and Intuitively

Simplified operator controls

Ergonomically designed microscopes improve more than comfort – they help to increase productivity as muscle strain gets reduced. The DM3 XL supports your team to deliver optimal results, even after long working hours.

With easily reachable controls, users leave their eyes on the sample and hands on the microscope while switching contrast techniques or illumination. The light intensity controller, positioned at the right side, can be comfortably controlled with the right hand. Variable ergotubes and focus knobs adjust to different body heights and allow for a stress-less working position.

The precision focus drive makes operation highly accurate with a 3-gear system, a sample protection stop and a torque adjustment mechanism. The focus stop prevents you from inadvertent damage. You can adjust a total travel range of 30 mm in the coarse, fine, or super-fine mode.

Your team consists of both microscope experts as well as novice operators without microscope experience alike. With its straightforward and intuitive functionality, the DM3 XL enables anyone in your team to detect defects fast and react accordingly. With simple and intuitive basic operation, contrast, and depth of field simple and clear, the Color Coded Diaphragm Assistant (CCDA) helps to speed up your work and minimize operational errors.



Different stage inserts for your specific sample needs

No matter what sample size and sample type you have to inspect, the DM3 XL offers you a choice of different stage inserts – metal inserts, wafer holders or mask holders are available. To easily locate the samples on the stage, the 150 mm x 150 mm stage offers the possibility for quick coarse or fine stage positioning.



For the inspection of microelectronic components, different stage inserts are available:

- > A wafer chuck for 6" samples
- > A metal plate for large flat samples



The 3-gear focus mechanism allows precise adjustments in coarse-, fine and super-fine steps.



Digital Image Documentation & Analysis

Software solutions for many needs

Upgrade your DM3 XL by choosing a dedicated software module to guide you through your application. The LAS X software provides high-quality solutions, particularly in environments that require high sample throughput. While the Montage module helps to increase throughput by creating high quality extended focus images, the Multistep module automatically captures and easily stores 2D images created from multiple tiled images. Let yourself be guided reliably through the process of acquiring, detecting, and measuring features and particles with the Image Analysis module and use an extensive range of measurement types with the Interactive Measurement module.



Documentation simplified

For efficient and high-quality documentation of your results, Leica offers a broad range of microscope cameras. All of our inspection cameras stand out for their fast live images, short reaction times, high resolution and clear contrast. Depending on your application needs, you can choose between an image resolution from 1.3 to 8 megapixels, exposure time of 100 μ sec to 30 seconds and color depth of up to 16 bits per color channel. Leica microscope cameras come with a standard interface like Firewire-B, USB 2.0 or USB 3.0 to be connected to a PC with a single interface cable.

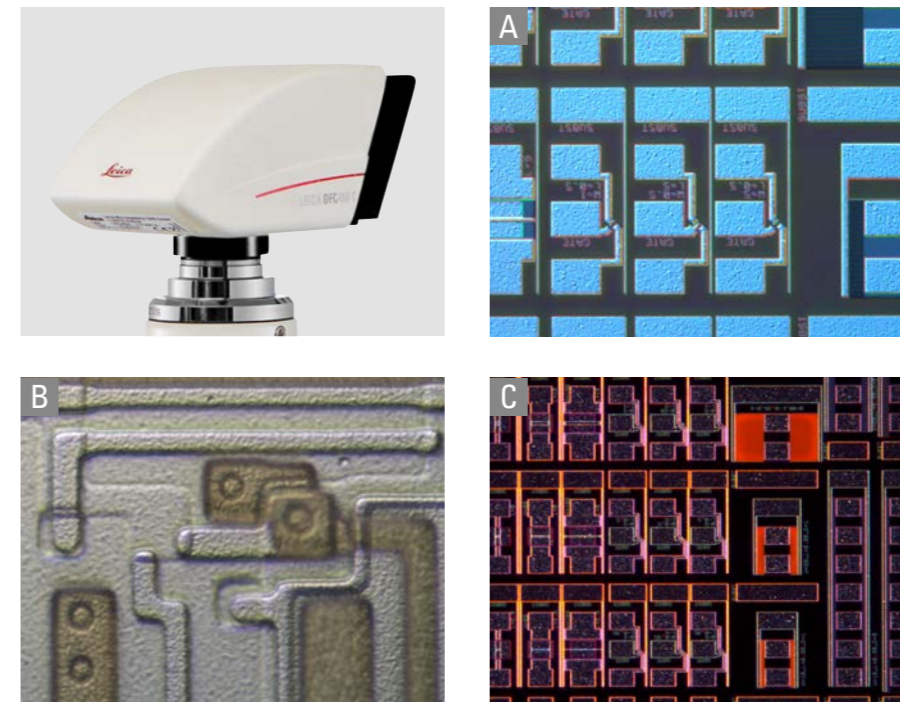

Images of wafer sample captured with:
A) 10x Differential Interference Contrast (DIC)
B) 100x brightfield (BF)_Oblique Illumination
C) 5x darkfield (DF)

DM3 XL

SYSTEM OVERVIEW

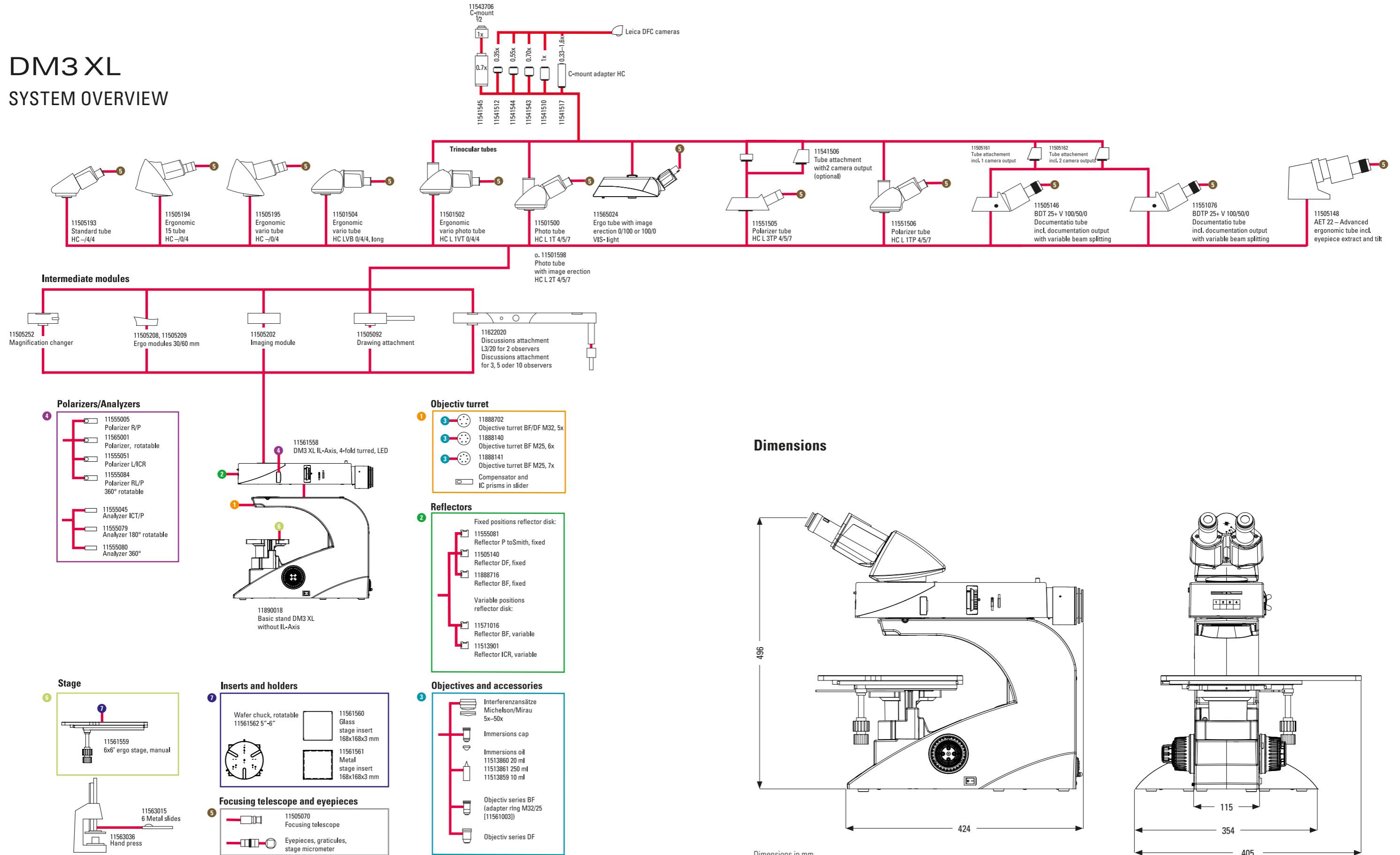

Dimensions

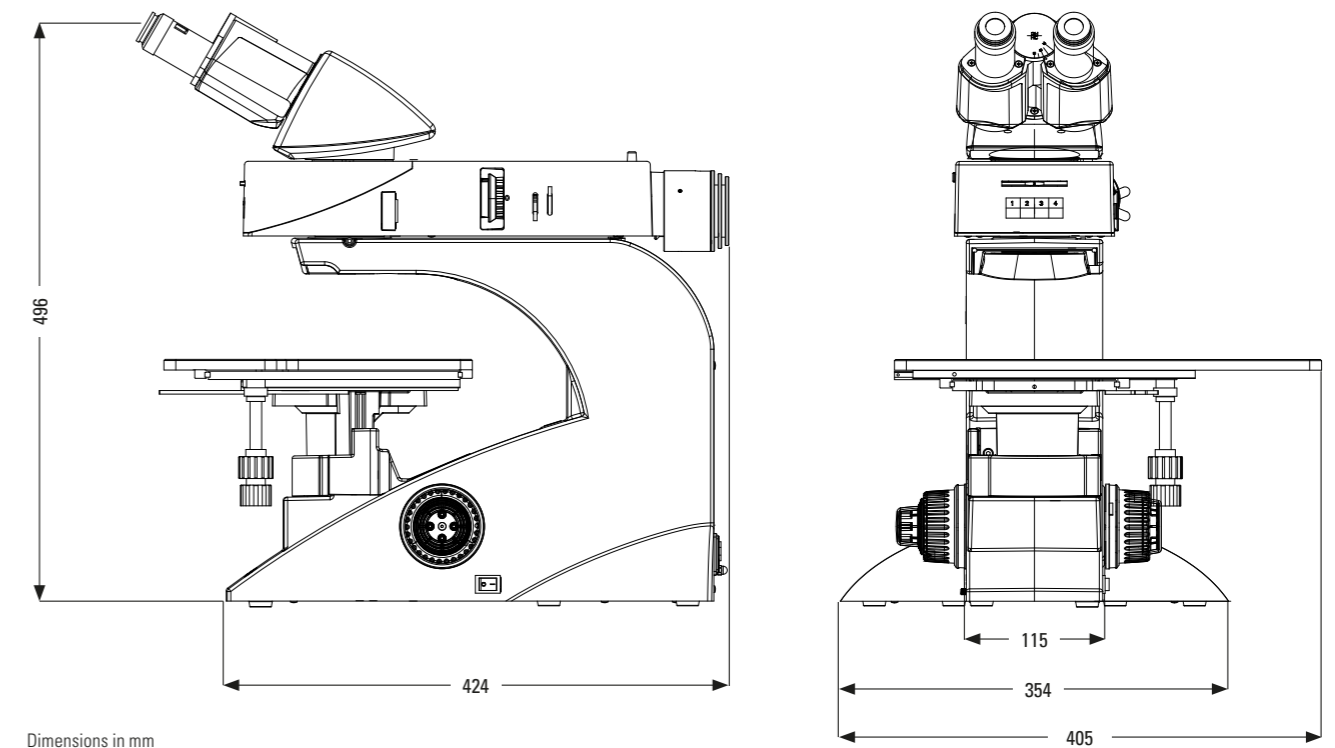

SPECIFICATIONS

DM3 XL	
Stand	Sturdy metal stand
Focusing	2-gear focusing (coarse/fine with 1 µm micrometer scale with top focus stop) or 3-gear focusing (coarse/medium/ fine with 1 and 4 µm micrometer scales with top focus stop) Torque coarse focus, adjustable stage height stop
Stage stroke	30 mm
Incident light	Robust incident light axis with 4-position reflector turret for BF/DF/POL/DIC and FLUO <ul style="list-style-type: none"> › with oblique illumination › with Color-coded Diaphragm Assistant (CCDA) › with centreable Aperture iris diaphragm › with IL-Filter magazine for 2 filters – Ø 32 mm <p>The following light sources can be adapted to all incident light axes:</p> <ul style="list-style-type: none"> › LED-Lamphousing with internal microscope control of the light intensity for incident light › Mirrorhousing 106, for simultaneous adaptation of two light sources › Fluo-illumination SFL 100, 4000 and 7000 › EL 6000, Hg 50, Hg 100, Xe 75 › 12 V 100 W Halogen (Lamp housing series 106 or 107/2) with separate transformer
Objective turret/ Objectives	5x BF/DF M32, 6x BF M25 and 7x BF M25 objective turret <ul style="list-style-type: none"> › HI PLAN EPI Objectives 5x, 10x, 20x › N PLAN EPI Objectives 2.5x - 100x › PLAN FLUOTAR Objectives 1.25x - 100x › PLAN APO Objectives 0,7x Macro 50x, 100x, 150x
Accessories	Optional magnification changer (1x, 1.5x, 2x). Optional measuring stage s for x, y and z measurements
Transmitted light	Illumination via external cold light source with light fiber
Power supply	Stabilized universal power supply unit, 90 - 230 V

CONNECT
WITH US!



Leica Microsystems GmbH · Ernst-Leitz-Strasse 17 - 37 · D-35578 Wetzlar
T +49 64 41 29-40 00 · F +49 64 41 29-41 55

www.leica-microsystems.com